

2 PLANTA
1 : 50

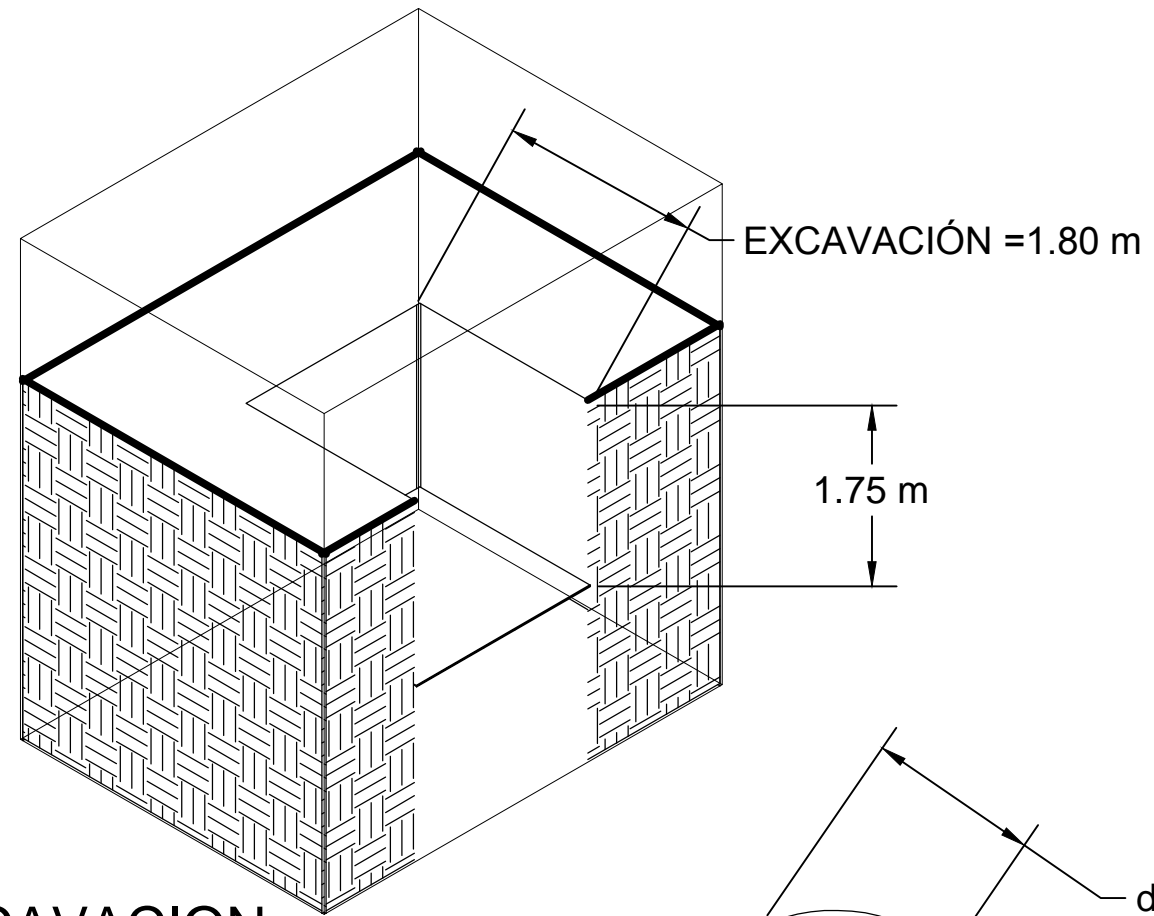

1 EXCAVACION

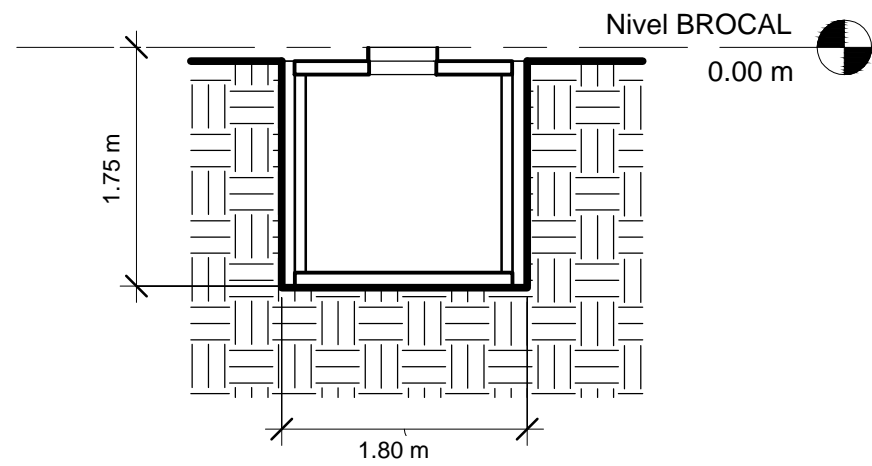

4 Sección 0
1 : 50

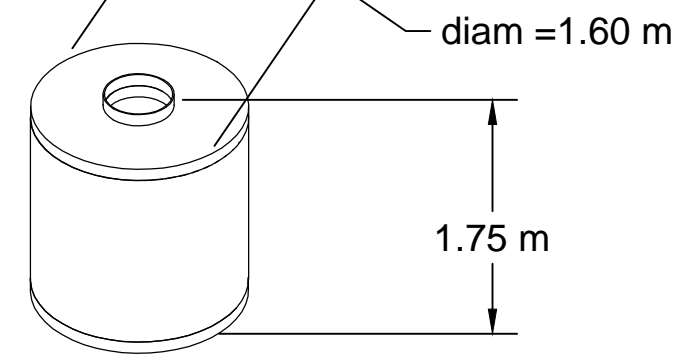

3 ISOMETRICO



No.	Description	Date

Propietario
cilindrico

2500 lts

Project number	0001
Date	Fecha de emisión
Drawn by	Author
Checked by	Checker

A102

Scale 1 : 50